

EI 100 x 1
 A-6064 T-SS P-900X
 Terminated, Single Section

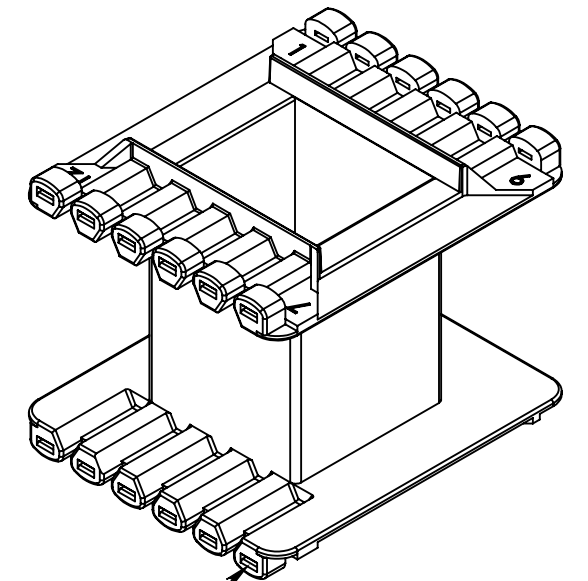

18 pin pockets accepting:
 Solder terminal (P-9002)
 PC terminal (P-9003)
 .110 disconnect (P-9009)

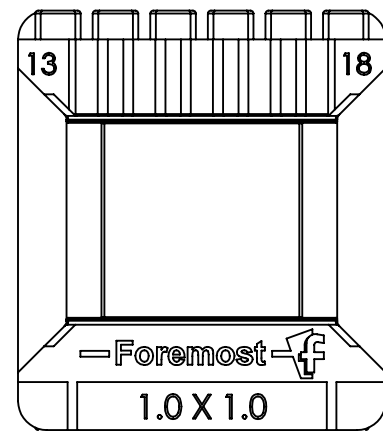
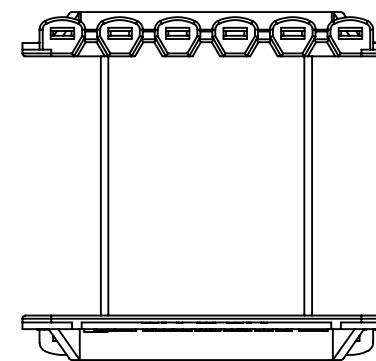
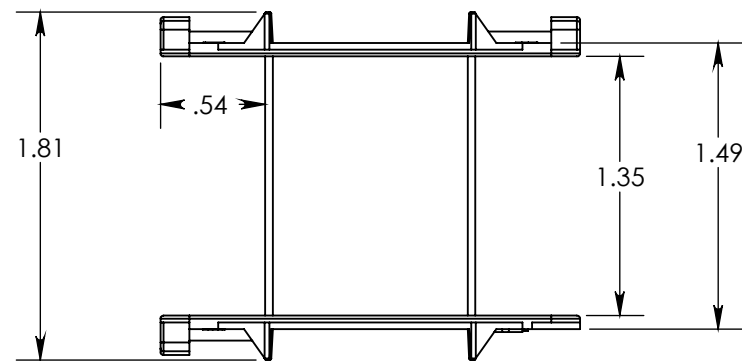
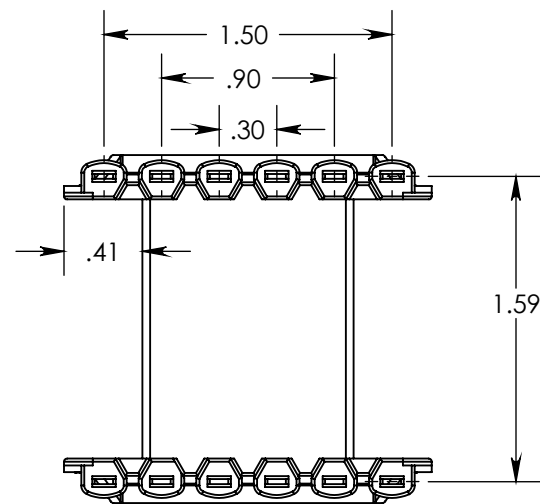
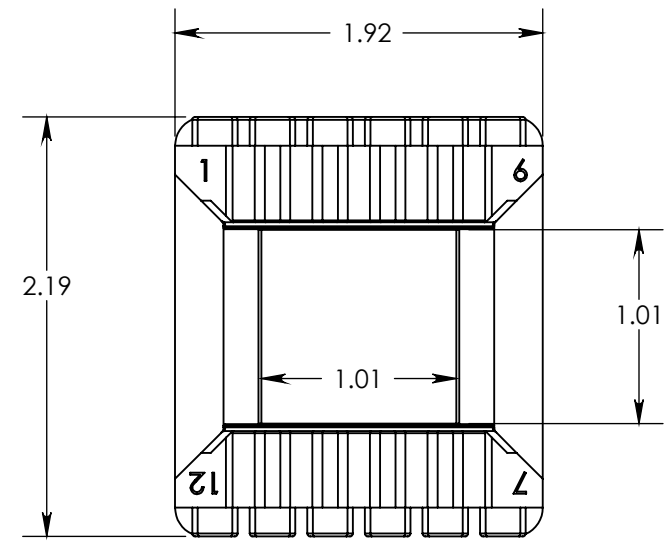
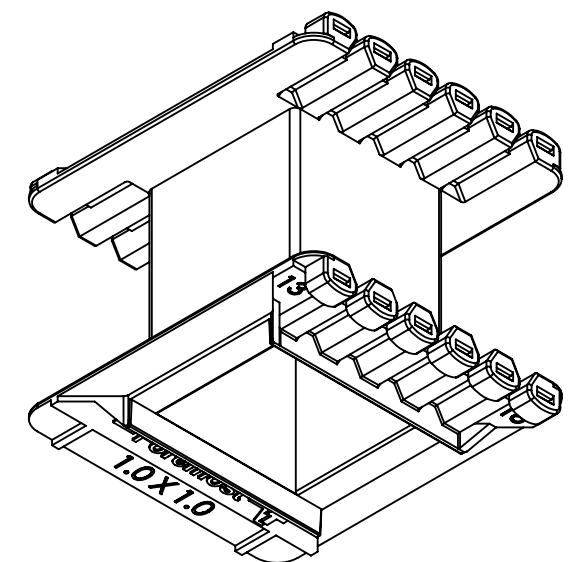

All dimensions for reference only. Samples available upon request.
 Foremost Plastic Products Company, inc. Phone 1-708-452-5300
 E-Mail: sales@foremostplastic.com Fax 1-708-452-0446